



# **Agilent TS-8989 PXI Functional Test System**

## **Site Preparation and Installation Guide**



**Agilent Technologies**

# Notices

© Agilent Technologies Inc. 2014

No part of this manual may be reproduced in any form or by any means (including electronic storage and retrieval or translation into a foreign language) without prior agreement and written consent from Agilent Technologies Inc. as governed by United States and international copyright laws.

## Manual Part Number

U8989-90000

## Edition

First Edition, January 22, 2014

Printed in Malaysia

Agilent Technologies Microwave Products (Malaysia) Sdn. Bhd.

Bayan Lepas Free Industrial Zone  
11900, Penang, Malaysia

## Warranty

**The material contained in this document is provided “as is,” and is subject to change, without notice, in future editions. Further, to the maximum extent permitted by the applicable law, Agilent disclaims all warranties, either express or implied, with regard to this manual and any information contained herein, including but not limited to the implied warranties of merchantability and fitness for a particular purpose. Agilent shall not be liable for errors or for incidental or consequential damages in connection with the furnishing, use, or performance of this document or of any information contained herein. Should Agilent and the user have a separate written agreement with warranty terms covering the material in this document that conflict with these terms, the warranty terms in the separate agreement shall control.**

## Technology Licenses

The hardware and or software described in this document are furnished under a license and may be used or copied only in accordance with the terms of such license.

## Restricted Rights Legend

U.S. Government Restricted Rights. Software and technical data rights granted to the federal government include only those rights customarily provided to end user customers. Agilent provides this customary commercial license in Software and technical data pursuant to FAR 12.211 (Technical Data) and 12.212 (Computer Software) and, for the Department of Defense, DFARS 252.227-7015 (Technical Data - Commercial Items) and DFARS 227.7202-3 (Rights in Commercial Computer Software or Computer Software Documentation).

## Safety Notices

### CAUTION

A **CAUTION** notice denotes a hazard. It calls attention to an operating procedure, practice, or the likes of that, if not correctly performed or adhered to, could result in damage to the product or loss of important data. Do not proceed beyond a **CAUTION** notice until the indicated conditions are fully understood and met.

---

### WARNING

A **WARNING** notice denotes a hazard. It calls attention to an operating procedure, practice, or the likes of that, if not correctly performed or adhered to, could result in personal injury or death. Do not proceed beyond a **WARNING** notice until the indicated conditions are fully understood and met.

---

# Table of Contents

## 1 Legal Information

Warranty	2
Technology Licenses	2
Restricted Rights Legend	3
Service and Support	4
Agilent on the web	4
Agilent by phone	4

## 2 Safety and Regulatory Information

Safety Summary	6
Safety Notices	6
General Safety Considerations	7
Environmental Conditions	8
Before Applying Power	9
Ground the System	9
Fuses	9
Operator Safety Information	10
Safety Symbols and Regulatory Markings	11
Declaration of Conformity	13
Electrostatic Discharge (ESD) Precautions	14
End of Life: Waste Electrical and Electronic Equipment (WEEE) Directive 2002/96/EC	15

### **3 Site Preparation and Power Requirements**

Preparing Your Site for the System	18
Typical test system configuration	18
System electrical specifications	20
System mechanical specifications	20
System dimensions	20
System Power Requirements	27
System Transportation Requirements	29

### **4 Installation**

Tools Required	32
Installation Procedure	33
Inspect for damage	33
Unpack the system	34
Install the cable routing strain relief bracket	39
Install the SLU card strain relief bracket	42
Connect the power supply cable	45
Connect the interface cables	46
Turn on the power	51

## List of Figures

- Figure 2-1 Examples of exposed connectors 10
- Figure 3-1 TS-8989 PXI functional test system (instrument interface view) 18
- Figure 3-2 TS-8989 PXI functional test system (DUT interface view) 19
- Figure 3-3 TS-8989 PXI functional test system (side view) 19
- Figure 3-4 TS-8989 PXI functional test system dimensions (front view without strain relief brackets) 21
- Figure 3-5 TS-8989 PXI functional test system dimensions (side view without strain relief brackets) 22
- Figure 3-6 TS-8989 PXI functional test system dimensions (top view without strain relief brackets) 23
- Figure 3-7 TS-8989 PXI functional test system dimensions (front view with strain relief brackets) 24
- Figure 3-8 TS-8989 PXI functional test system dimensions (side view with strain relief brackets) 25
- Figure 3-9 TS-8989 PXI functional test system dimensions (top view with strain relief brackets) 26
- Figure 3-10 Power inlet location on the instrument interface of the TS-8989 test system 27
- Figure 3-11 Cable connection from the SLU to the PXI on the TS-8989 test system 28
- Figure 4-1 TS-8989 subsystem sections 47
- Figure 4-2 Interface cable label example (\*SLU\_12\_J3\*) 48
- Figure 4-3 Interface cable label example (\*PXI\_5\_AUXOUT\*) 48
- Figure 4-4 Interface cable label example (\*PXI\_3\_CH1-8\*) 49
- Figure 4-5 Interface cable label example (\*SLU\_Chassis\*) 49
- Figure 4-6 Interface cable label example (PIN 1) 50
- Figure 4-7 TS-8989 system power switch (instrument interface view) 51
- Figure 4-8 PXI subsystem power switch (DUT interface view) 51

**THIS PAGE HAS BEEN INTENTIONALLY LEFT BLANK.**

## List of Tables

Table 2-1	General environmental requirements	8
Table 2-2	Safety symbols and regulatory markings	11
Table 2-3	Suggested anti-static solutions for site planning	14
Table 3-1	System electrical specifications	20
Table 3-2	System mechanical specifications	20

**THIS PAGE HAS BEEN INTENTIONALLY LEFT BLANK.**





# 1 Legal Information

Warranty	2
Technology Licenses	2
Restricted Rights Legend	3
Service and Support	4
Agilent on the web	4
Agilent by phone	4



## Warranty

The material contained in this document is provided “as is,” and is subject to being changed, without notice, in future editions.

Further, to the maximum extent permitted by applicable law, Agilent disclaims all warranties, either express or implied, with regard to this manual and any information contained herein, including but not limited to the implied warranties of merchantability and fitness for a particular purpose.

Agilent shall not be liable for errors or for incidental or consequential damages in connection with the furnishing, use, or performance of this document or of any information contained herein.

Should Agilent and the user have a separate written agreement with warranty terms covering the material in this document that conflict with these terms, the warranty terms in the separate agreement shall control.

## Technology Licenses

The hardware and/or software described in this document are furnished under a license and may be used or copied only in accordance with the terms of such license.

## Restricted Rights Legend

If software is for use in the performance of a U.S. Government prime contract or subcontract, Software is delivered and licensed as “Commercial computer software” as defined in DFAR 252.227-7014 (June 1995), or as a “commercial item” as defined in FAR 2.101(a) or as “Restricted computer software” as defined in FAR 52.227-19 (June 1987) or any equivalent agency regulation or contract clause. Use, duplication, or disclosure of Software is subject to Agilent Technologies’ standard commercial license terms, and non-DOD Departments and Agencies of the U.S. Government will receive no greater than Restricted Rights as defined in FAR 52.227-19(c)(1-2)(June 1987). U.S. Government users will receive no greater than Limited Rights as defined in FAR 52.227-14 (June 1987) or DFAR 252.227-7015 (b)(2)(November 1995), as applicable in any technical data.

## Service and Support

Any adjustment, maintenance, or repair of this product must be performed by qualified personnel. Contact your customer engineer through your local Agilent Service Center.

### Agilent on the web

You can find information about technical and professional services, product support, and equipment repair and service on the web: <http://www.agilent.com/>

Double-click the link to **Test & Measurement**. Select your country from the drop-down menus. The web page that appears next has contact information specific for your country.

### Agilent by phone

If you do not have access to the Internet, call one of the numbers in the “[Contact us](#)” section at the end of this manual.



## 2 Safety and Regulatory Information

Safety Summary	6
Safety Notices	6
General Safety Considerations	7
Environmental Conditions	8
Before Applying Power	9
Ground the System	9
Fuses	9
Operator Safety Information	10
Safety Symbols and Regulatory Markings	11
Declaration of Conformity	13
Electrostatic Discharge (ESD) Precautions	14
End of Life: Waste Electrical and Electronic Equipment (WEEE) Directive 2002/96/EC	15



# Safety Summary

The following general safety precautions must be observed during all phases of operation of this instrument. Failure to comply with these precautions or with specific warnings elsewhere in this manual violates safety standards of design, manufacture, and intended use of the instrument. Agilent Technologies, Inc. assumes no liability for the customer's failure to comply with these requirements.

# Safety Notices

## CAUTION

A CAUTION notice denotes a hazard. It calls attention to an operating procedure, practice, or the like, that, if not correctly performed or adhered to, could result in damage to the product or loss of important data. Do not proceed beyond a CAUTION notice until the indicated conditions are fully understood and met.

---

## WARNING

**A WARNING notice denotes a hazard. It calls attention to an operating procedure, practice, or the like that, if not correctly performed or adhered to, could result in personal injury or death. Do not proceed beyond a WARNING notice until the indicated conditions are fully understood and met.**

---

## General Safety Considerations

This product is provided with a protective earth terminal. The protective features of this product may be impaired if it is used in a manner not specified in the operation instructions.

### WARNING

- **DO NOT OPERATE IN AN EXPLOSIVE ATMOSPHERE. Do not operate the product in the presence of flammable gases or flames.**
  - **DO NOT REMOVE RACK PANELS OR INSTRUMENT COVERS. Operating personnel must not remove any rack panels or instrument covers. Component replacement and internal adjustments must be made only by qualified service personnel. Products that appear damaged or defective should be made inoperative and secured against unintended operation until they can be repaired by a qualified service personnel.**
  - **The protection provided by the TS-8989 system may be impaired if the system is used in a manner not specified by Agilent.**
-

# Environmental Conditions

The TS-8989 Automotive Electronics PXI Functional Test System is designed for indoor use only. [Table 2-1](#) shows the general environmental requirements.

**Table 2-1** General environmental requirements

Environment condition	Requirement
Maximum altitude	2000 meters
Operating temperature	5 °C to 40 °C
Relative humidity	The test system is designed to operate in the range from 5% to 80% relative humidity (non-condensing)

### CAUTION

This product is designed for use in Installation Category II and Pollution Degree 2, per IEC 61010-1 and 664 respectively.



## Before Applying Power

Verify that the product is set to match the available line voltage and that all safety precautions are taken. Note the external markings of the instruments described in [“Safety Symbols and Regulatory Markings”](#).

## Ground the System

Agilent chassis' are provided with a grounding-type power plug. The instrument chassis and cover must be connected to an electrical ground to minimize shock hazard. The ground pin must be firmly connected to an electrical ground (safety ground) terminal at the power outlet. Any interruption of the protective (grounding) conductor or disconnection of the protective earth terminal will cause a potential shock hazard that could result in personal injury.

## Fuses

Use only fuses with the required rated current, voltage, and specified type (fast acting). Do not use repaired fuses or short-circuited fuse holders. Doing so could cause a shock or fire hazard.

### **WARNING**

**To avoid electrical hazards, all system internal fuses must be replaced by trained and qualified personnel.**

---

## Operator Safety Information

**WARNING**

Module connectors and test signal cables connected to them cannot be operator-accessible.

Cables and connectors are considered inaccessible if a tool (such as a screwdriver, wrench, or socket) or a key (for equipment in a locked cabinet) is required to gain access to a conductive surface connected to any cable conductor (High, Low, or Guard).

**WARNING**

Do not touch the exposed connector pins or remove connected cables while the system is powered ON (see [Figure 2-1](#)).









Figure 2-1 Examples of exposed connectors



## Safety Symbols and Regulatory Markings

Symbols and markings on the system, in manuals, and on instruments alert you to potential risks, provide information about conditions, and comply with international regulations. [Table 2-2](#) defines the symbols and markings you may find in a manual or on an instrument.









**Table 2-2** Safety symbols and regulatory markings

Symbol	Description
<b>Safety symbol</b>	
	Warning: risk of electrical shock.
	Warning: hot surface.
	Caution: refer to accompanying documents.
	Laser radiation symbol: marked on products that have a laser output.
	Alternating current.
	Both direct and alternating current.
	3-phase alternating current.
	Earth (ground) terminal.
	Protective earth (ground) terminal.

## 2 Safety and Regulatory Information

### Safety Symbols and Regulatory Markings

**Table 2-2** Safety symbols and regulatory markings (continued)

Symbol	Description
	Frame or chassis terminal.
	Terminal is at earth potential. Used for measurement and control circuits designed to be operated with one terminal at earth potential.
	Terminal for a neutral conductor on permanently installed equipment.
	Terminal for a line conductor on permanently installed equipment.
	Standby (supply); units with this symbol are not completely disconnected from the AC mains when this switch is turned off. To completely disconnect the unit from the AC mains, either disconnect the power cord, or have a qualified electrician install an external switch.
<b>Regulatory marking</b>	
	The CE mark is a registered trademark of the European Community. If it is accompanied by a year, it indicates the year the design was proven.
	The CSA mark is a registered trademark of the Canadian Standards Association.
	The C-tick mark is a registered trademark of the Spectrum Management Agency of Australia. This signifies compliance with the Australian EMC Framework regulations under the terms of the Radio Communications Act of 1992.
<b>ISM - 1A</b>	This text indicates that the instrument is an Industrial Scientific and Medical Group 1 Class A product (CISPER 11, Clause 4).

## Declaration of Conformity

The Declaration of Conformity (DoC) for this instrument is available on the Agilent website. You can search the DoC by its product model or description at the web address below.

<http://regulations.corporate.agilent.com/DoC/search.htm>

**NOTE**

If you are unable to search for the respective DoC, contact your local Agilent representative.

---

## Electrostatic Discharge (ESD) Precautions

Static electricity is destructive to your production process and the TS-8989. Careless handling and poor site planning can cause system reliability problems and reduce your product yield. The system may not be as easily damaged as the modules you will be testing, but good anti-static planning will help ensure high reliability.

The ESD symbol below indicates areas where ESD caution must be exercised. This is to prevent damage to instruments and/or test disruption.



**Caution: static sensitive**

Electrostatic discharge in this area may cause equipment damage and/or test disruption.

While not an exhaustive list of anti-static precautions, [Table 2-3](#) provides suggestions to consider as you plan your system area.

**Table 2-3** Suggested anti-static solutions for site planning

Precaution	Suggested solution
Anti-static flooring	Plan to use an anti-static floor covering or mats.
Grounding straps	Plan for foot straps in conjunction with anti-static flooring and wrist straps for system operators.

## End of Life: Waste Electrical and Electronic Equipment (WEEE) Directive 2002/96/EC

This instrument complies with the WEEE Directive (2002/96/EC) marking requirement. This affixed product label indicates that you must not discard this electrical or electronic product in domestic household waste.

### Product Category:

With reference to the equipment types in the WEEE directive Annex 1, this instrument is classified as a “Monitoring and Control Instrument” product.

The affixed product label is as shown below.



**Do not dispose in domestic household waste.**

To return this unwanted instrument, contact your nearest Agilent Service Center, or visit

[www.agilent.com/environment/product](http://www.agilent.com/environment/product)

for more information.

## **2 Safety and Regulatory Information**

End of Life: Waste Electrical and Electronic Equipment (WEEE) Directive 2002/96/EC

**THIS PAGE HAS BEEN INTENTIONALLY LEFT BLANK.**





### 3 Site Preparation and Power Requirements

Preparing Your Site for the System	18
Typical test system configuration	18
System electrical specifications	20
System mechanical specifications	20
System dimensions	20
System Power Requirements	27
System Transportation Requirements	29



## Preparing Your Site for the System

### WARNING

- No operator-serviceable parts inside. Refer servicing to qualified personnel. To prevent electrical shock, do not remove instrument covers.
- The protection provided by the TS-8989 system may be impaired if the system is used in a manner not specified by Agilent.

### Typical test system configuration

Figure 3-1, Figure 3-2, and Figure 3-3 shows a typical hardware configuration of the TS-8989 PXI functional test system.

**Figure 3-1** TS-8989 PXI functional test system (instrument interface view)

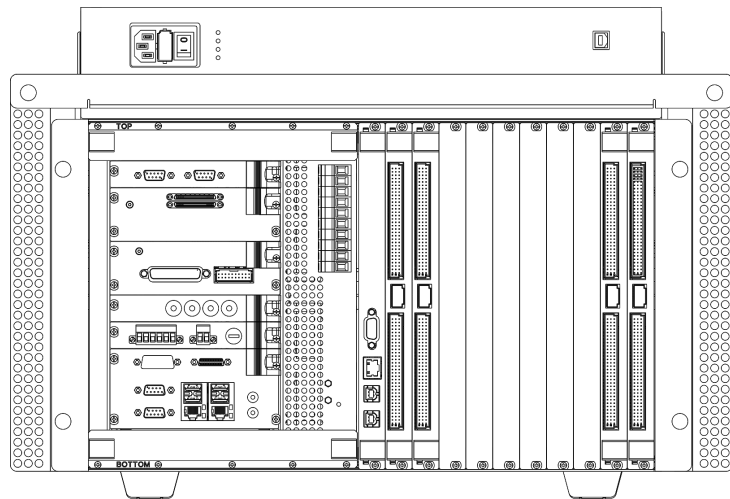

Figure 3-2 TS-8989 PXI functional test system (DUT interface view)

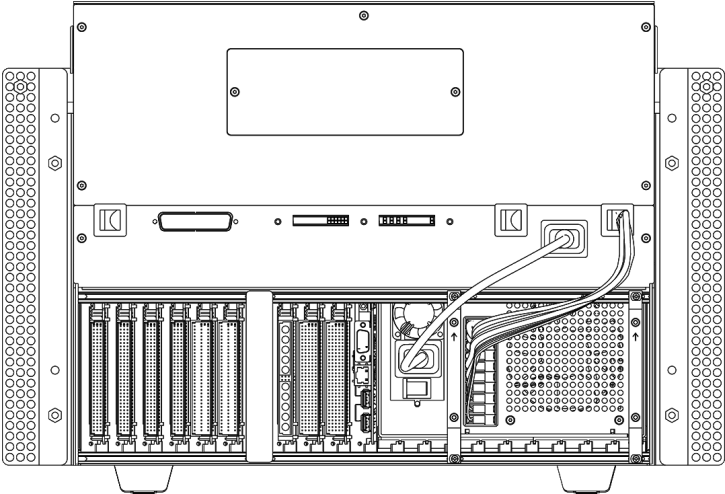
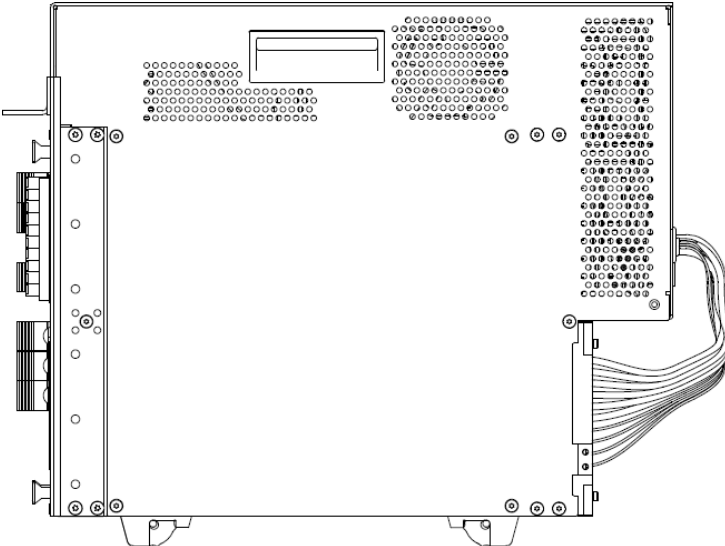

Figure 3-3 TS-8989 PXI functional test system (side view)



## System electrical specifications

**Table 3-1** System electrical specifications

<b>Input voltage</b>	100 - 240 VAC
<b>Frequency</b>	50/60 Hz
<b>Power</b>	675 W maximum

## System mechanical specifications

**Table 3-2** System mechanical specifications

<b>Height</b>	372.06 mm (79.5 in)
<b>Width</b>	545.92 mm (23.6 in)
<b>Depth</b>	457.65 mm (35.6 in)
<b>Estimated weight</b>	50 kg (600 lbs)

## System dimensions

The TS-8989 PXI functional test system can be mounted in a 19-inch EIA rack cabinet. It fits in eight rack unit (8U) of space.

Figure 3-4, Figure 3-5, and Figure 3-6 shows the isometric view of the TS-8989 system without the cable routing strain relief brackets, meanwhile Figure 3-7, Figure 3-8, and Figure 3-9 shows the isometric view with the cable routing strain relief brackets.

With the given dimension in millimeters, you can further optimize your workspace by designing a custom structure rack to fit above or under a manufacturing workstation or

conveyor system. Agilent recommends you to allocate an additional 100 mm space in front of system and 100 mm space at the rear of system for cabling.

Figure 3-4 TS-8989 PXI functional test system dimensions (front view without strain relief brackets)

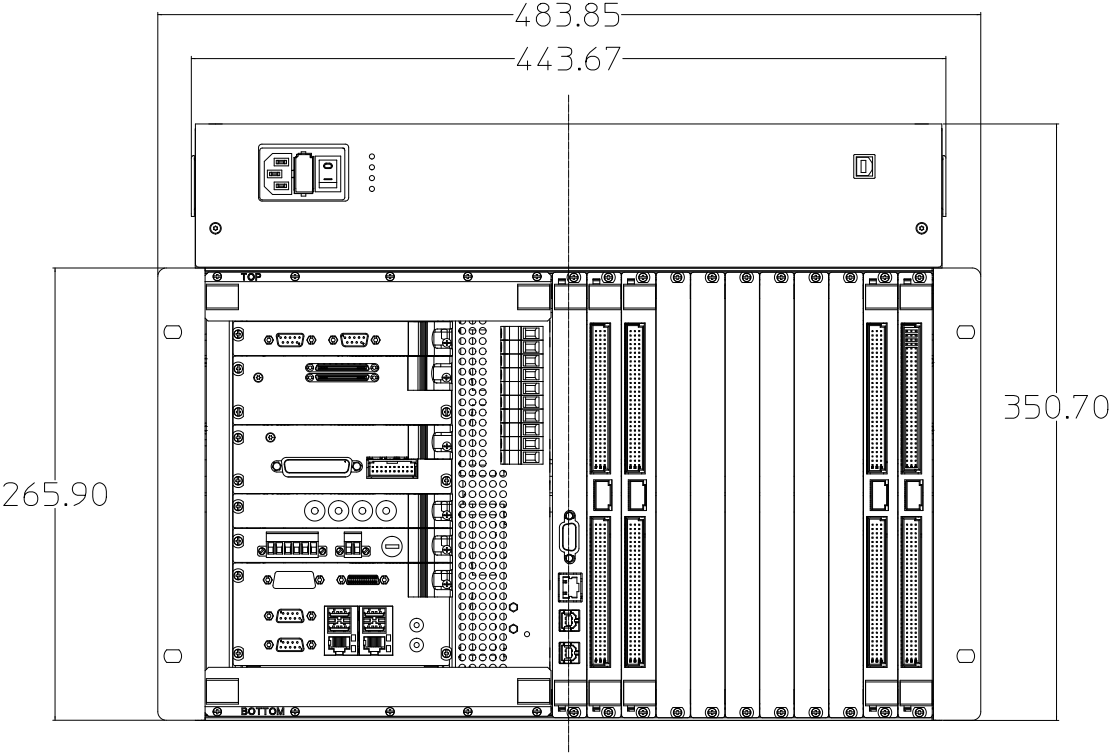

### 3 Site Preparation and Power Requirements

Preparing Your Site for the System

**Figure 3-5** TS-8989 PXI functional test system dimensions (side view without strain relief brackets)

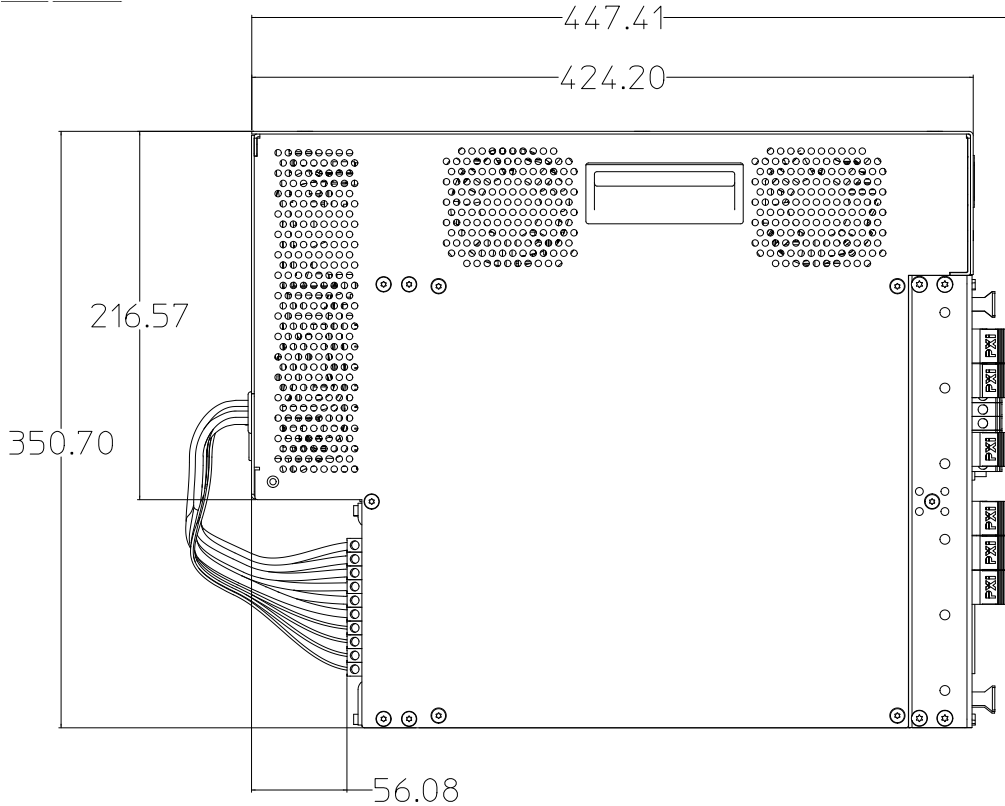
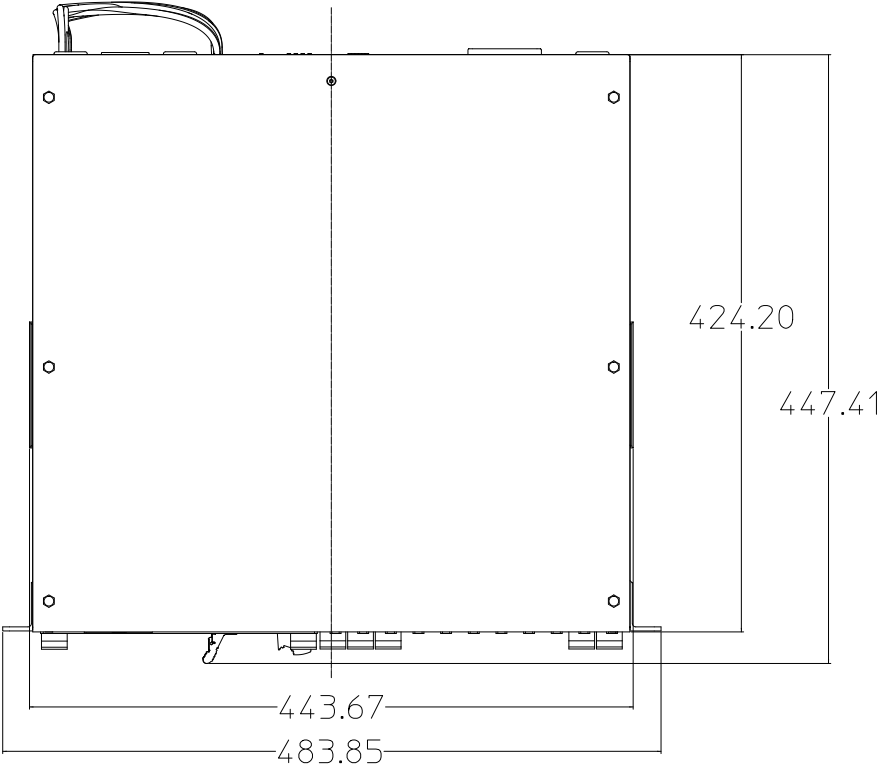

Figure 3-6 TS-8989 PXI functional test system dimensions (top view without strain relief brackets)



### 3 Site Preparation and Power Requirements

Preparing Your Site for the System

**Figure 3-7** TS-8989 PXI functional test system dimensions (front view with strain relief brackets)

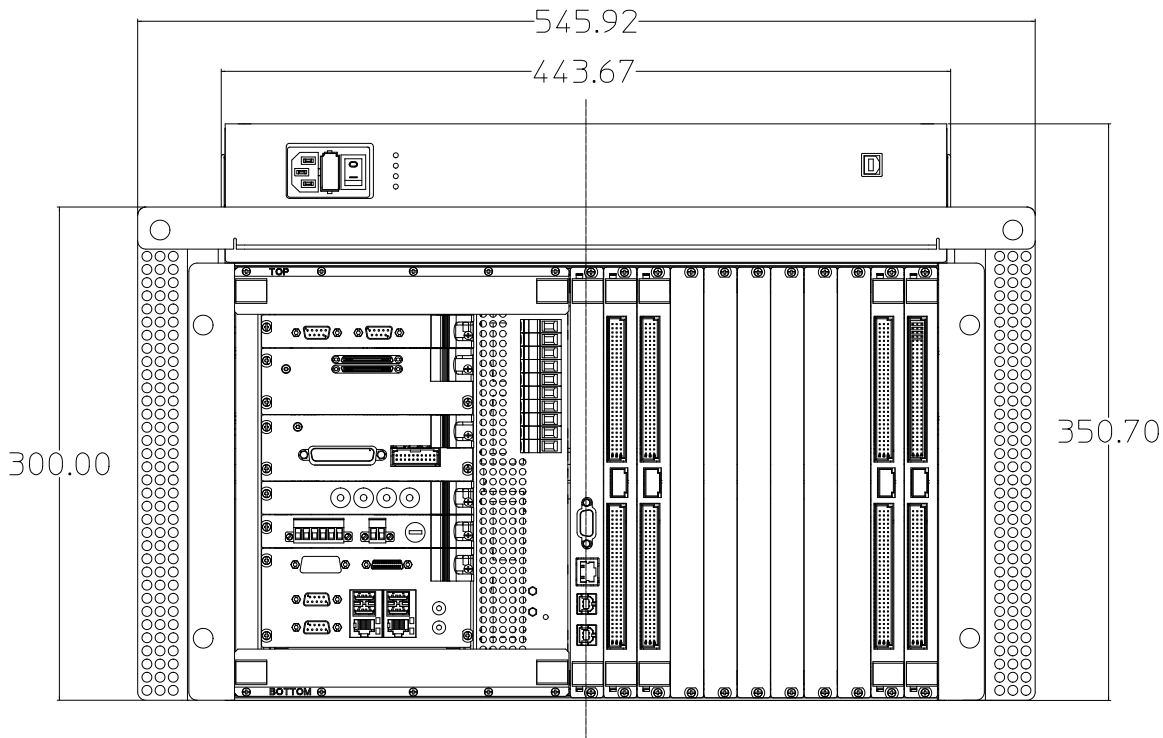
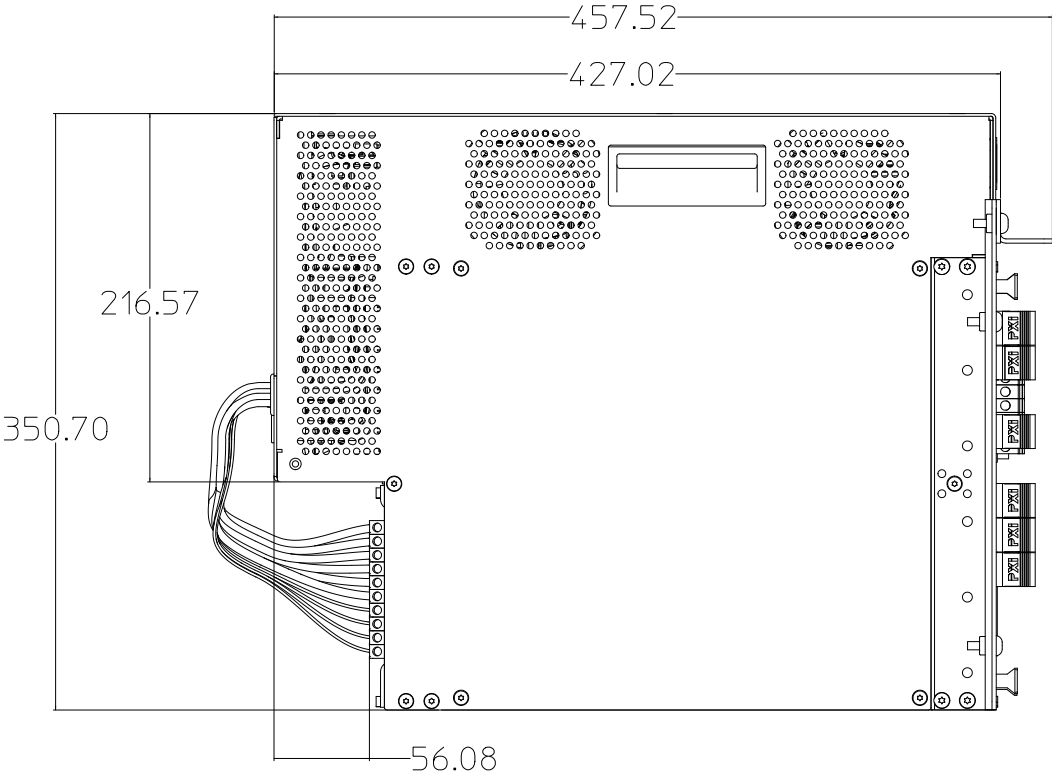



Figure 3-8 TS-8989 PXI functional test system dimensions (side view with strain relief brackets)



### 3 Site Preparation and Power Requirements

Preparing Your Site for the System

**Figure 3-9** TS-8989 PXI functional test system dimensions (top view with strain relief brackets)

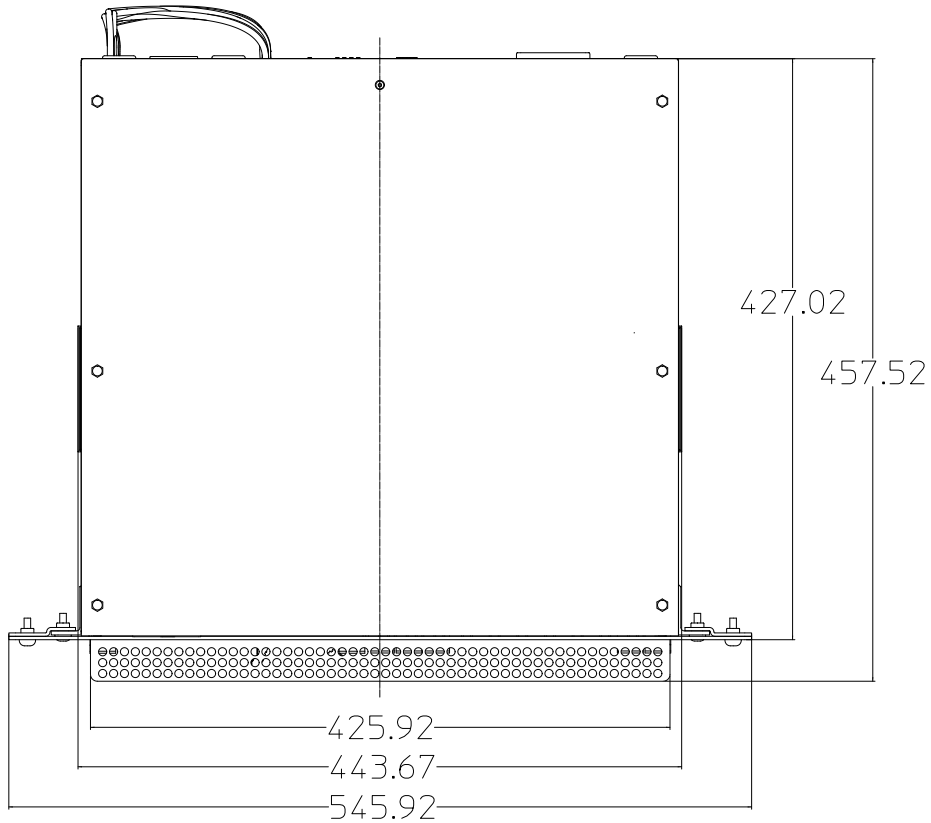

## System Power Requirements

The TS-8989 PXI functional test system has been designed for use with a single phase AC voltage of 100 - 240 VAC.

Figure 3-10 shows the location of the power inlet in your system.

**Figure 3-10** Power inlet location on the instrument interface of the TS-8989 test system

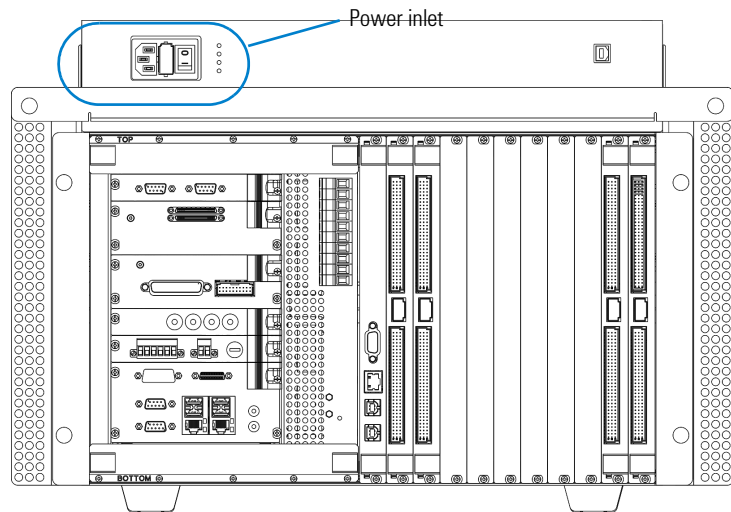

The TS-8989 power inlet requirements are listed below.

- Input voltage: 100 VAC to 240 VAC
- Frequency: 50/60 Hz
- Fuses: 8 A Fast-Acting High-Breaking Capacity Fuse

### 3 Site Preparation and Power Requirements

#### System Power Requirements

- Cable connection from the SLU to the PXI:
  - The cable connection from the SLU to the PXI uses a C14 plug
  - Do not connect this power for other instruments
  - Cable part number: 8120-1575

**Figure 3-11** Cable connection from the SLU to the PXI on the TS-8989 test system

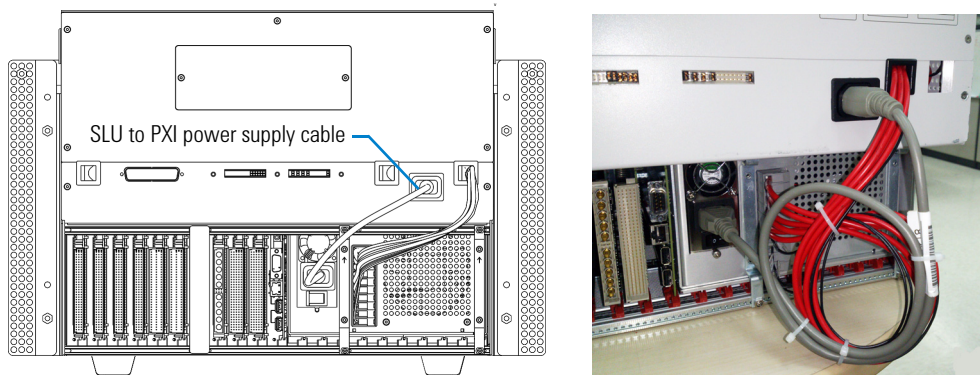

## System Transportation Requirements

The TS-8989 system is shipped from the factory in a big box on one pallet (i.e. a palletized box).

When transporting the system on its pallet, take note that the system must be transported in an upright position.

Always transport the system in a box with a pallet. It is recommended to use back the shipping box provided by Agilent.

### NOTE

#### Recommended pallet jack dimensions:

- Width: 20.25 inches
  - Length: 36 inches and above
- 

### WARNING

**Chassis exceeds 48 kg. Use a mechanical lift to lift the chassis. The chassis should be transported by using a rolling cart. Do not lift the chassis by the handles on the front and rear of the chassis. If you plan to mount the chassis at the top of a rack, the mechanical lift must be able to raise the chassis to approximately 60" (1.5 meters).**

---

### **3 Site Preparation and Power Requirements**

System Transportation Requirements

**THIS PAGE HAS BEEN INTENTIONALLY LEFT BLANK.**

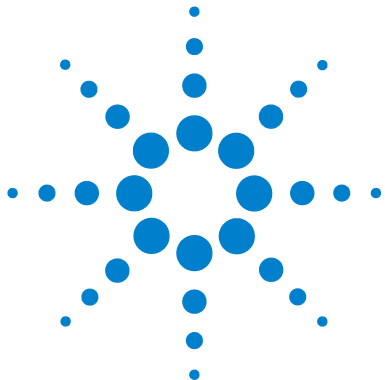

## 4 Installation

Tools Required	32
Installation Procedure	33
Inspect for damage	33
Unpack the system	34
Install the cable routing strain relief bracket	39
Install the SLU card strain relief bracket	42
Connect the power supply cable	45
Connect the interface cables	46
Turn on the power	51



## Tools Required

- ✓ Utility knife or scissors (to unpack the system)
- ✓ One #2 Phillips screwdriver

### NOTE

Six screws and nuts are included in the accessories box. These screws and nuts are used to install the cable routing strain relief brackets on to the TS-8989 system.

---



# Installation Procedure

## Inspect for damage

Before unpacking the system, carefully inspect the shipping container for any shipping damage. Signs of damage may include a dented or torn shipping container or cushioning material that indicates signs of unusual stress or compacting. Report any damage to the shipping agent immediately, as such damage is not covered by the warranty.

To find the warranty information on your TS-8989 system, go to [www.agilent.com/find/warranty](http://www.agilent.com/find/warranty) and enter your model number (TS-8989) in the **Product Number** field, and enter the serial number from the chassis rear panel in the **Serial No.** field.

### CAUTION

To avoid damage when handling the TS-8989 system and modules, do not touch the exposed connector pins.

---

## Unpack the system

The TS-8989 PXI functional test system and its accessories are packed in a cardboard carton with foam padding for protection during shipment.

Carefully unpack the system by referring to the figures below.

### NOTE

- Keep the packing material to ensure that the test system can be moved safely to another location in the future.
- If repackaging is needed, please reverse the unpacking procedure.

- 1 Using a utility knife or a pair of scissors — remove all the remaining packing tape and plastic wrap, and unfold the outer carton box flaps.

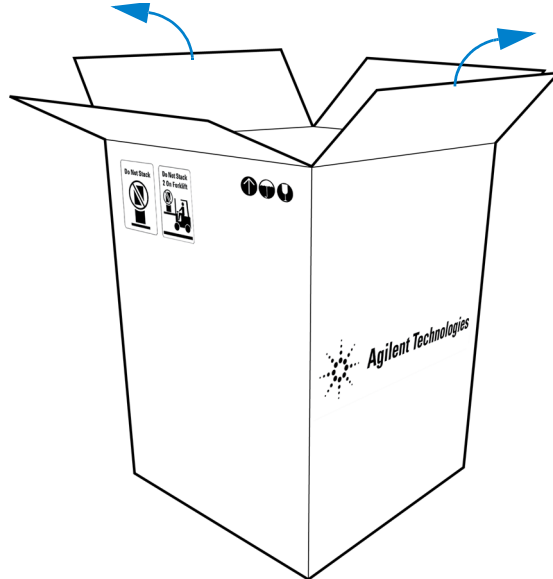

- 2 Gently lift the outer carton box straight up. Avoid using any sharp objects to cut or tear the outer carton box.

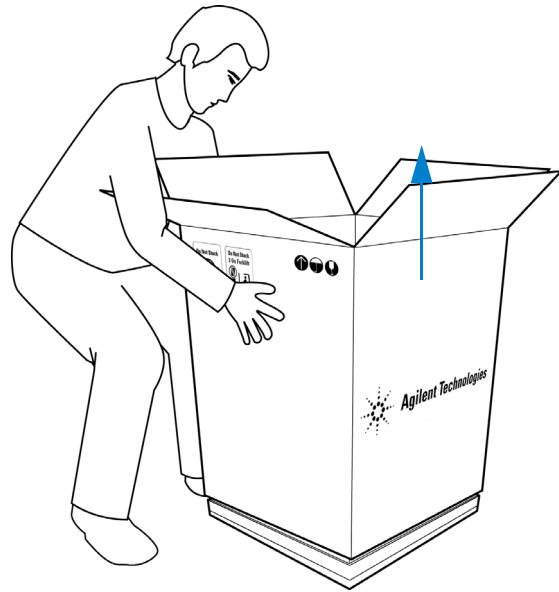

**NOTE**

Save the outer carton box for future use.

## 4 Installation

### Installation Procedure

- 3 The figure below shows the contents of the package. Remove and unpack each item carefully.

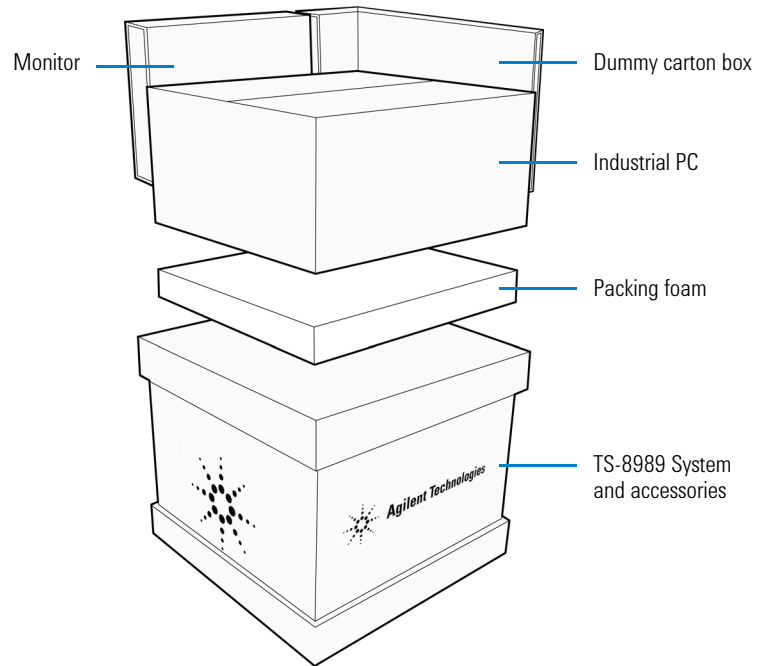

#### NOTE

- If you did not opt to order the monitor and/or the industrial PC, the item(s) will be replaced by a dummy carton box in your shipment.
- Save all individual carton boxes and packing materials for future use.

- 4 The figure below shows the contents of the carton box containing the TS-8989 system and its accessories. Remove the TS-8989 system and place on a flat surface.

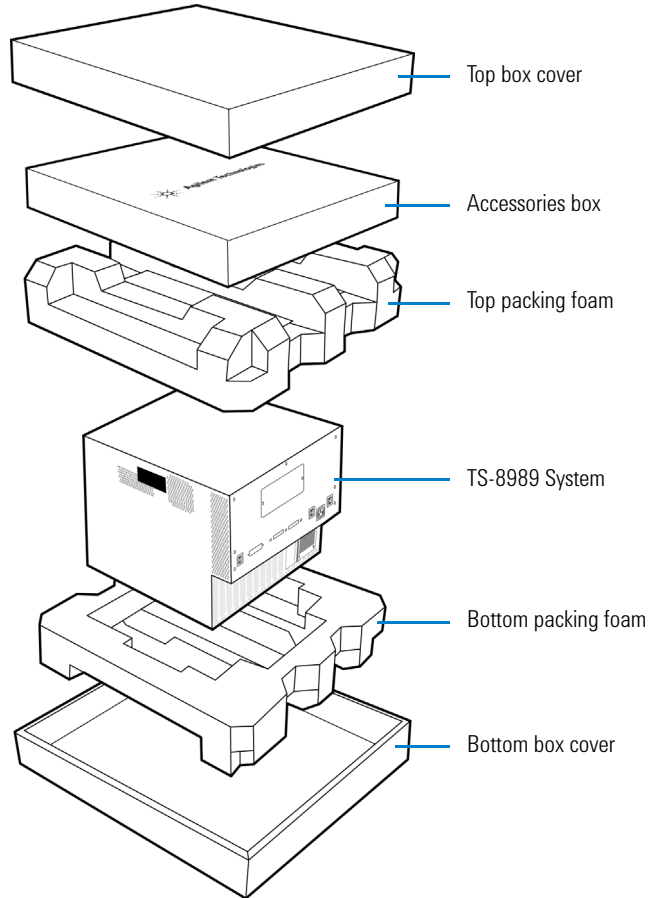

**CAUTION**

To avoid damage when handling the system, do not touch exposed connector pins.

## 4 Installation

### Installation Procedure

- 5 The figure below shows the contents of the TS-8989 accessories box. Verify that the standard accessories and your ordered options are included in the shipment according to the list of accessories found in the *TS-8989 Wiring Guide and Hardware Reference*.

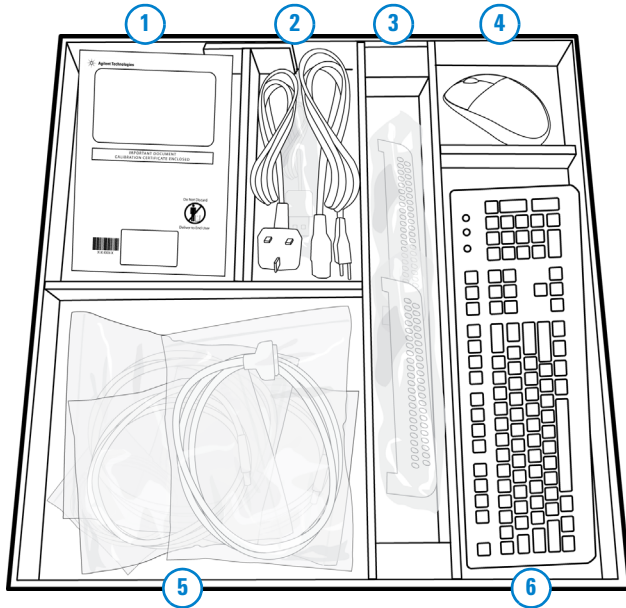

- 1 FTC/CoC reports and CD-ROMs containing manuals and software
- 2 Power cable and miscellaneous
- 3 Cable routing and SLU card strain relief brackets
- 4 Mouse
- 5 Interface cables
- 6 Keyboard

#### NOTE

- Some sections of the accessories box will be left empty if the corresponding accessory is not ordered (e.g. mouse, keyboard, and strain relief brackets).
- For any question or problems with the shipment, refer to the Agilent contact numbers on the back of this manual.

## Install the cable routing strain relief bracket

The cable routing strain relief bracket eases the cable routing from the PXI modules to the SLU cards, especially to the Universal Instrument Routing Cards.

Using cable ties, tie the interface cables to the holes on the cable routing strain relief bracket to create a neat and tidy cable route on the instrument interface.

- 1 Locate the cable routing strain relief side brackets (P/N: U8989-01206), top bracket (P/N: U8989-01205), and bracket nuts (P/N: 2580-0211) and screws (P/N: E9900-06001).

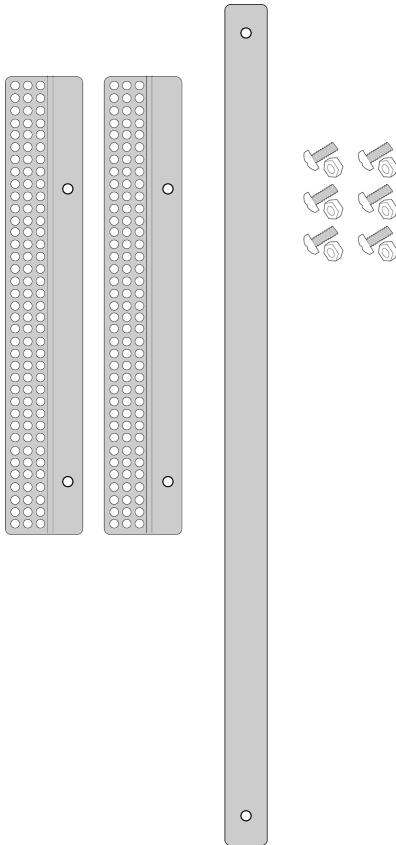

## 4 Installation

### Installation Procedure

- 2 Place the left cable routing strain relief side bracket behind the TS-8989 system's side rail. Align the mounting holes.

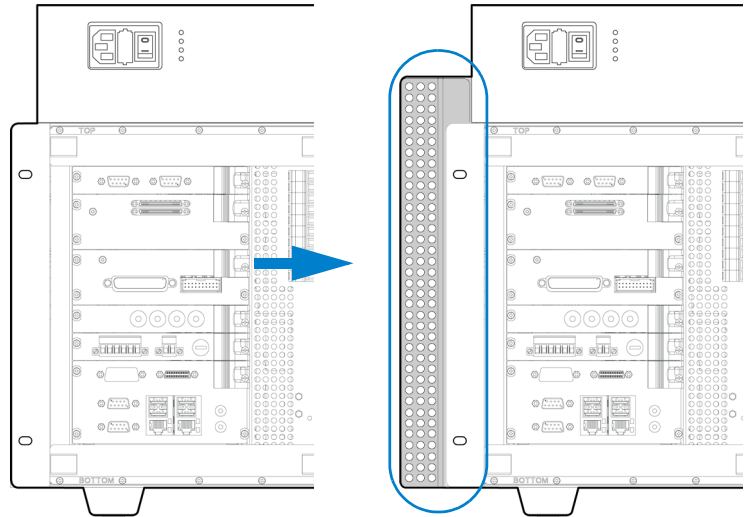

- 3 Using a #2 Phillips screwdriver, insert and tighten the nuts and screws securely.

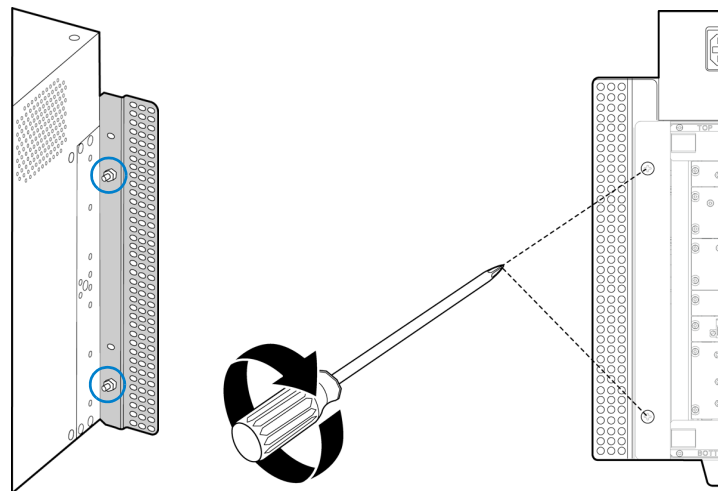



- 4 Repeat [step 2](#) and [step 3](#) for the right cable routing strain relief side bracket.

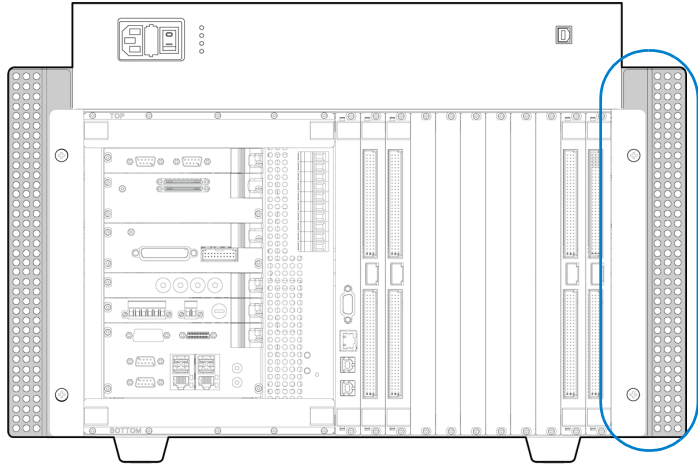

- 5 Finally, place the cable routing strain relief top bracket in front of the installed cable routing strain relief side brackets. Align the mounting holes. Using the #2 Phillips screwdriver, insert and tighten the nuts and screws securely.

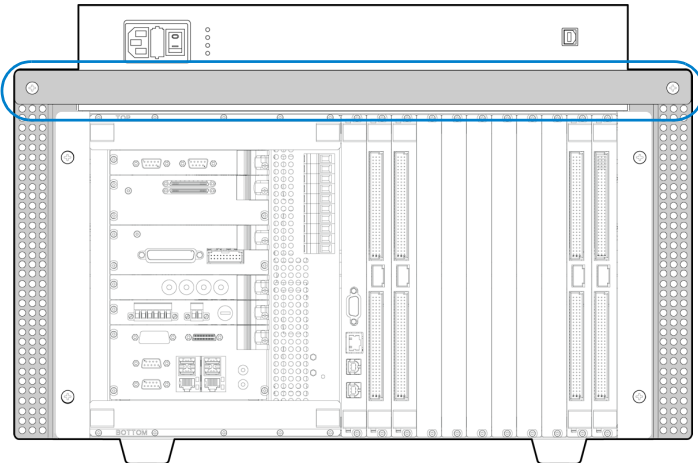

## Install the SLU card strain relief bracket

The SLU card strain relief bracket is designed to help hold and secure the interface cables connected to the SLU cards.

Using cable ties, tie the interface cables to the holes on the SLU card strain relief bracket to reduce the strain on the SLU card and to avoid accidentally disconnecting the interface cables.

- 1 Locate the SLU card strain relief brackets (P/N: U8989-01207).

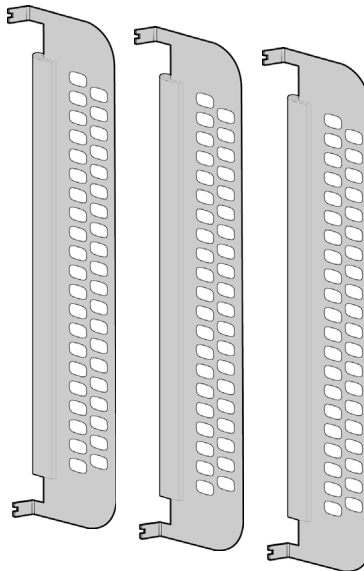

- Using a #2 Phillips screwdriver, loosen the top and bottom screws on an SLU card slightly. Insert the SLU card strain relief bracket's grooves behind the screws.

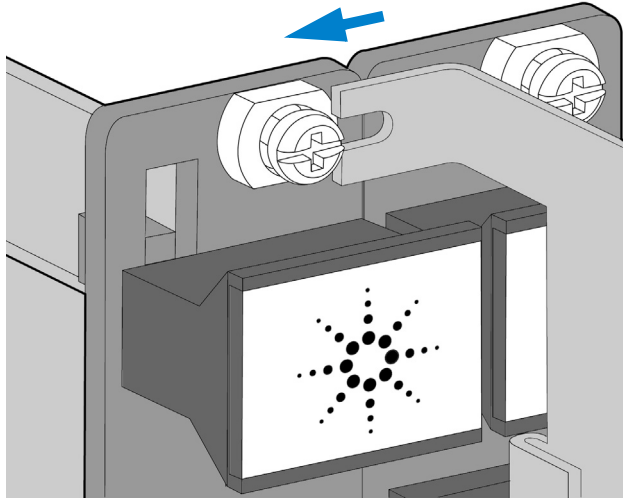

- Tighten the top and bottom screws securely.

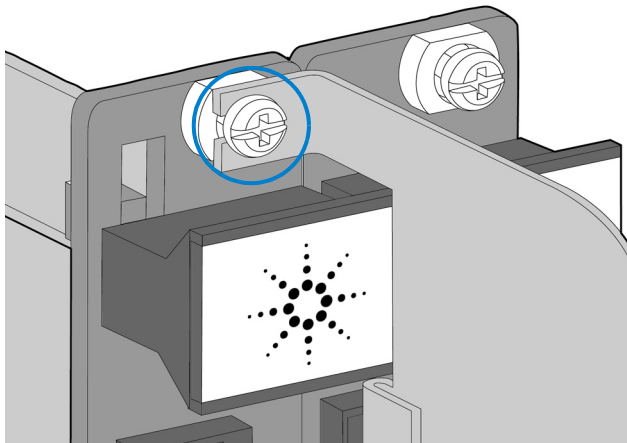

## 4 Installation

Installation Procedure

4 The SLU card with the strain relief bracket installed is shown below.

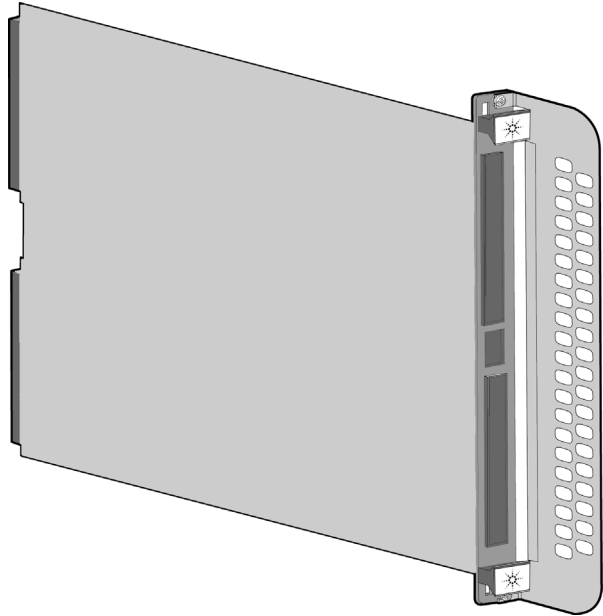

5 Using cable ties, tie the interface cables to the holes on the SLU card strain relief bracket.

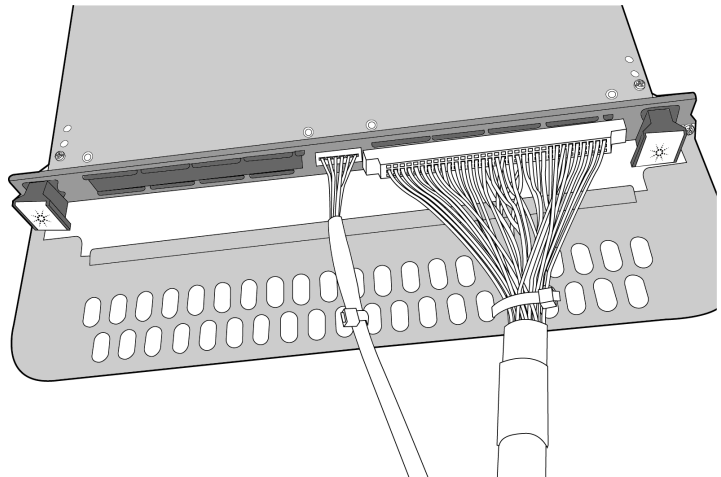

## Connect the power supply cable

Connect the female end of the power cable to the power connector on the instrument interface side of the TS-8989 system.

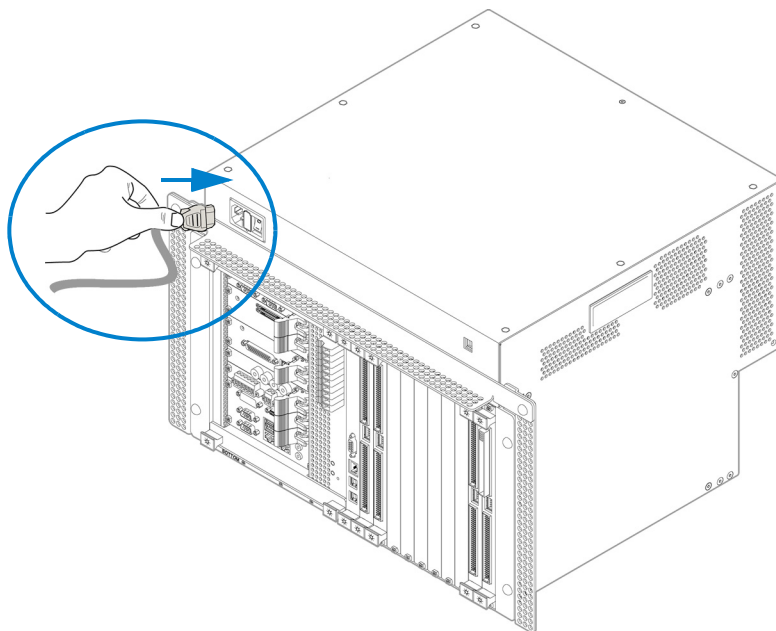

Plug the male end into a three-prong grounded electrical outlet.

### CAUTION

DO NOT turn on the TS-8989 system until the interface cables are connected. Turn off the power to the TS-8989 system when changing the connections between the cards or instrument.

## Connect the interface cables

For ease of use, each individual interface cable is labeled *at both ends* to help you ascertain its proper connections.

The connection label is marked with an asterisk (\*) in front and behind of the label name (e.g. \*PXI\_3\_Input\*).

The label name comprises three variables:

**\* <SUBSYSTEM>\_<SLOT NUMBER>\_<CONNECTOR NAME> \***

Using the information provided by these three variables, you will be able to determine the proper subsystem section, slot number, and connector to connect the end of the cable to.

### <SUBSYSTEM>

The <SUBSYSTEM> variable has three possible inputs: SLU, PXI, or PCI.

The subsystem sections are shown in [Figure 4-1](#).

### <SLOT NUMBER>

The <SLOT NUMBER> variable indicates the slot number in the subsystem that you should connect the end of the cable to.

The slot numbers are printed on the card or instrument.

### <CONNECTOR NAME>

The <CONNECTOR NAME> variable indicates the name of the connector on the card or instrument that you should connect the end of the cable to.

The connector names are printed on the card or instrument. See [page 48](#) for examples on how to read the cable labels.

#### NOTE

The pins on some interface cables are also labeled (e.g. PIN 0 or PIN 1). On the TS-8989 system, take note that for cables connected to the instrument routing card, J3 connector, the lowest pin (i.e. PIN 1) to the highest pin (i.e. PIN 6) is always counted from the bottom up.

Figure 4-1 TS-8989 subsystem sections

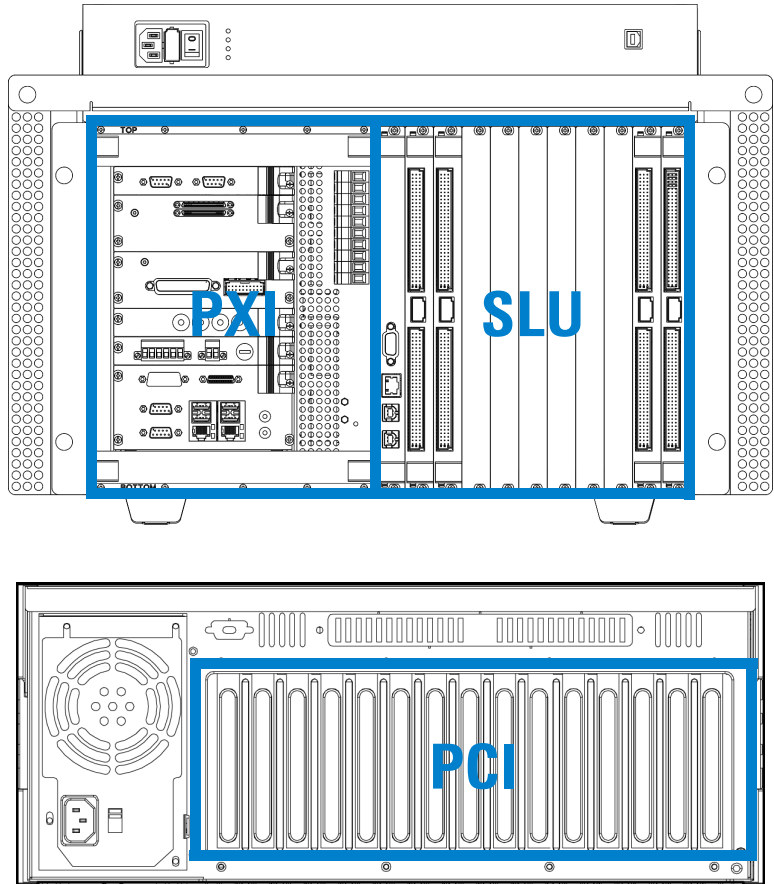

## Examples

**Figure 4-2** Interface cable label example (\*SLU\_12\_J3\*)



The label on this end of the cable reads **\*SLU\_12\_J3\***. You should connect the end of that cable to the *J3* connector, in *Slot 12* of the *SLU subsystem*.

**Figure 4-3** Interface cable label example (\*PXI\_5\_AUXOUT\*)



The label on this end of the cable reads **\*PXI\_5\_AUXOUT\***. You should connect the end of that cable to the *AUXOUT* connector, in *Slot 5* of the *PXI subsystem*.



**Figure 4-4** Interface cable label example (\*PXI\_3\_CH1-8\*)



The label on this end of the cable reads **\*PXI\_3\_CH1-8\***. You should connect the end of that cable to the *CH1-8* connector, in *Slot 3* of the *PXI subsystem*.

**Figure 4-5** Interface cable label example (\*SLU\_Chassis\*)



The label on this end of the cable reads **\*SLU\_Chassis\***. You should connect the end of that cable to the *Chassis* connector of the *SLU subsystem*.

**Figure 4-6** Interface cable label example (PIN 1)

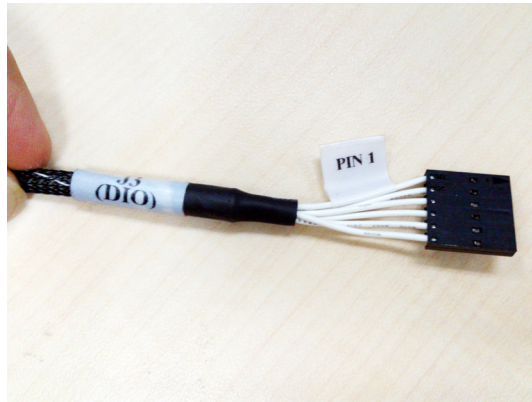

The end of this cable connects to the J3 connector of the instrument routing card. PIN 1 is labeled to help you determine the proper connections.

For the 12-pin J2 connector, PIN 1 (the lowest pin) is counted from the bottom. Refer to the TS-8989 Wiring Guide and Hardware Reference for more information about the instrument routing card's pinout.

## Turn on the power

Turn on the power to the TS-8989 system. The power switch is on the right of the power connector. The STATUS LEDs lights up when the TS-8989 system is powered on.

**Figure 4-7** TS-8989 system power switch (instrument interface view)



Ensure that the power switch on the PXI subsystem is turned on as well on the DUT interface side.

**Figure 4-8** PXI subsystem power switch (DUT interface view)

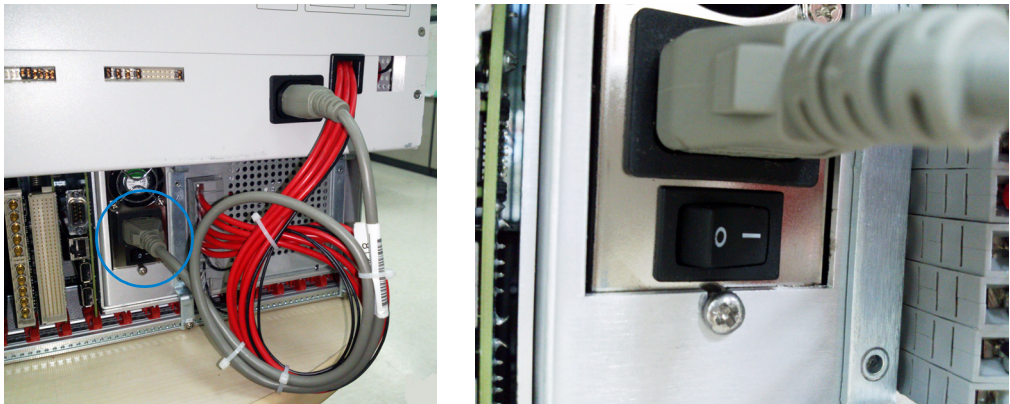

## **4 Installation**

Installation Procedure

**THIS PAGE HAS BEEN INTENTIONALLY LEFT BLANK.**

**www.agilent.com**

**Contact us**

To obtain service, warranty, or technical assistance, contact us at the following phone or fax numbers:

United States:

(tel) 800 829 4444 (fax) 800 829 4433

Canada:

(tel) 877 894 4414 (fax) 800 746 4866

China:

(tel) 800 810 0189 (fax) 800 820 2816

Europe:

(tel) 31 20 547 2111

Japan:

(tel) (81) 426 56 7832 (fax) (81) 426 56 7840

Korea:

(tel) (080) 769 0800 (fax) (080) 769 0900

Latin America:

(tel) (305) 269 7500

Taiwan:

(tel) 0800 047 866 (fax) 0800 286 331

Other Asia Pacific Countries:

(tel) (65) 6375 8100 (fax) (65) 6755 0042

Or visit Agilent World Wide Web at:

[www.agilent.com/find/assist](http://www.agilent.com/find/assist)

Product specifications and descriptions in this document are subject to change without notice. Always refer to the Agilent website for the latest revision.

© Agilent Technologies Inc. 2014

First Edition, January 22, 2014  
U8989-90000



**Agilent Technologies**